

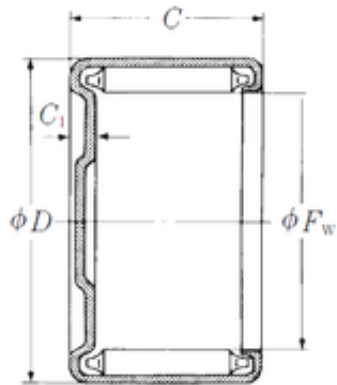

# BEARING DRIVESHAFT, INC.

## NSK M-24201 needle roller bearings



Bearing No. M-24201

Size	38.1x47.625x31.75 mm
Bore Diameter	38,1 mm
Outer Diameter	47,625 mm
Width	31,75 mm
Fw	38,1 mm
D	47,625 mm
C	31,75 mm
C2	3 mm
Weight	0,13 Kg
Basic dynamic load rating (C)	59,5 kN

M-24201 Bearing 2D drawings and 3D CAD models